

## Features

- Wide 2:1 Input Voltage Range
- Very Low Stand-by (no-load) Power Consumption  
50mW typ. and 150mW max.
- Very High Efficiency up to 86%
- 3W Single and Dual outputs
- I/O Isolation 2KVDC and 4KVDC Option
- Operating Temperature Range -40°C to +85°C
- Continuous Short Circuit Protection
- Remote ON/OFF Control

## SIP8, Single & Dual Outputs



RoHS

## Description

The BS3 series is an excellent performance and, Wide 2:1 input voltage ranges: 4.5V-9V,9V-18V,18V-36V and 36V-75V The highest efficiency allows -40°C to +85°C operating temperatures. The very low stand-by (no-load)input power consumption 50mW typ,makes them an ideal solution for application in battery-powered equipment and instrumentation.

## Derating Graph

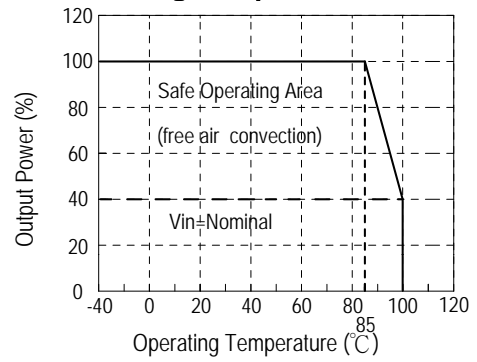

## Selection Guide

Part Number	Input Voltage Range VDC	Output Voltage VDC	Output Current max. mA	Efficiency Typ. %	Max. Capacitive Load
BS3-xx03SX	4.5-9,9-18,18-36,36-75	3.3 VDC	600 mA	77,78,79,80	1000uF
BS3-xx05SX	4.5-9,9-18,18-36,36-75	5 VDC	600 mA	80,82,83,83	1000uF
BS3-xx09SX	4.5-9,9-18,18-36,36-75	9 VDC	333 mA	80,84,84,84	680uF
BS3-xx12SX	4.5-9,9-18,18-36,36-75	12 VDC	250 mA	83,85,85,85	470uF
BS3-xx15SX	4.5-9,9-18,18-36,36-75	15 VDC	200 mA	83,85,85,85	330uF
BS3-xx05DX	4.5-9,9-18,18-36,36-75	±5 VDC	±300 mA	80,82,83,83	±470uF
BS3-xx12DX	4.5-9,9-18,18-36,36-75	±12 VDC	±125 mA	82,84,86,85	±100uF
BS3-xx15DX	4.5-9,9-18,18-36,36-75	±15 VDC	±100 mA	82,84,86,85	±47uF

X=Isolation(KVDC),X=2=2KVDC,X=4=4KVDC

xx=Vin(Nominal), xx=05=5VDC(4.5-9VDC)

xx=12=12VDC(9-18VDC)

xx=24=24VDC(18-36VDC)

xx=48=48VDC(36-75VDC)

## Specifications

(measured at  $T_A=25^{\circ}\text{C}$ , nominal input voltage, full load and after warm-up)

Input Voltage Range	4.5-9V,9-18V,18-36V,36-75V	2:1
Input Filter		Capacitor
Output Voltage Accuracy	Nominal $V_{in}$ and full load	$\pm 2\%$
Line Voltage Regulation	$V_{in}=\text{min}$ to max,full load	$\pm 0.5\%$ typ.
Load Voltage Regulation	20% to 100% of full load	$\pm 0.5\%$ typ.
Output Ripple and Noise	20MHz BW	60mVp-p max.
Operating Frequency		100kHz min.
No Load Power Consumption		50mW typ. / 150mW max.
Isolation Voltage	1 second	2 & 4K VDC
Isolation Capacitance	100KHz tested	30PF max.
Isolation Resistance	500VDC, input to output	15G $\Omega$ min.
Short Circuit Protection		Continuous
Temperature Coefficient	-40 $^{\circ}\text{C}$ to +85 $^{\circ}\text{C}$ ambient	0.015%/ $^{\circ}\text{C}$ typ.
Temperature Rise at Full Load		15 $^{\circ}\text{C}$ typ.
Operating Temperature Range	see Graph	-40 $^{\circ}\text{C}$ to +100 $^{\circ}\text{C}$
Operating Case Temperature		+110 $^{\circ}\text{C}$ max.
Storage Temperature Range		-55 $^{\circ}\text{C}$ to +125 $^{\circ}\text{C}$
Relative Humidity		95% RH
Case Material	UL94-V0	Non-conductive black plastic
Potting Material	UL94-V0	Epoxy
Package Weight		4.7g
Packing Quantity		23 pcs per Tube
Lead Temperature		300 $^{\circ}\text{C}$ max. 1.5mm from case for 10 sec
Remote Power OFF (leave open if not used) (15VDC max.)	Device ON Device OFF Device OFF Stand by input current	open or <0.8VDC CTRL>1.5VDC 0.5mA max.
MTBF(+25 $^{\circ}\text{C}$ )	using MIL-HDBK 217F	3050x10 <sup>3</sup> hours
(+85 $^{\circ}\text{C}$ )	using MIL-HDBK 217F	247x10 <sup>3</sup> hours

## Functional Block Diagram

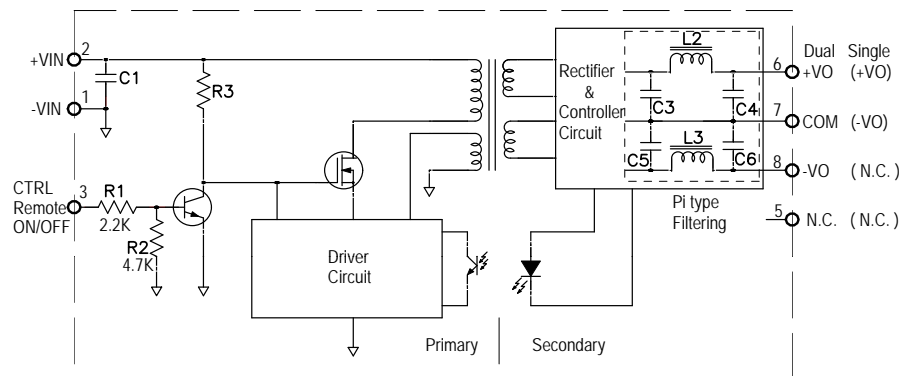

Input Voltage	C1 Values
4.5-18VDC	10uF/25V
9-36VDC	4.7uF/50V
18-75VDC	1uF/100V

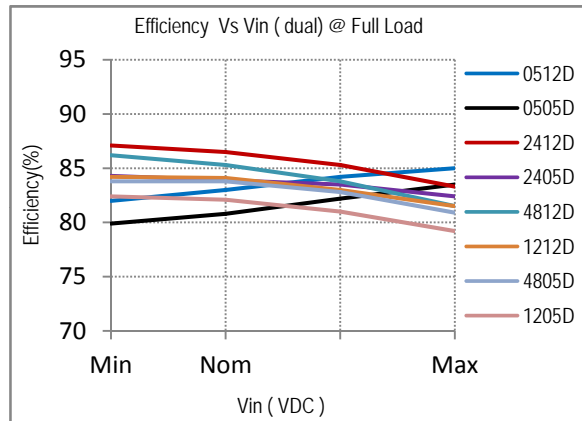
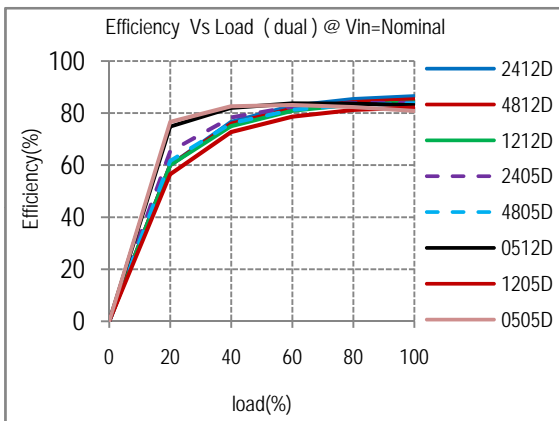
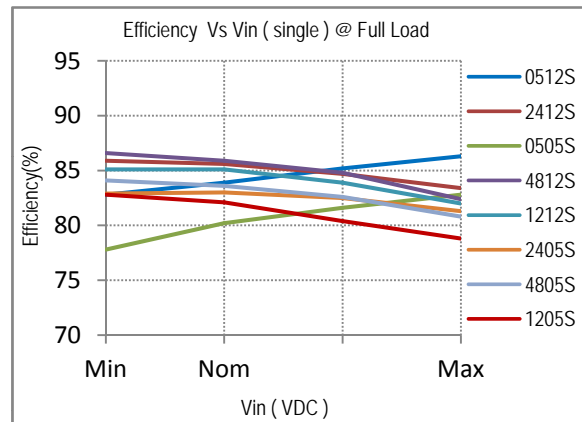
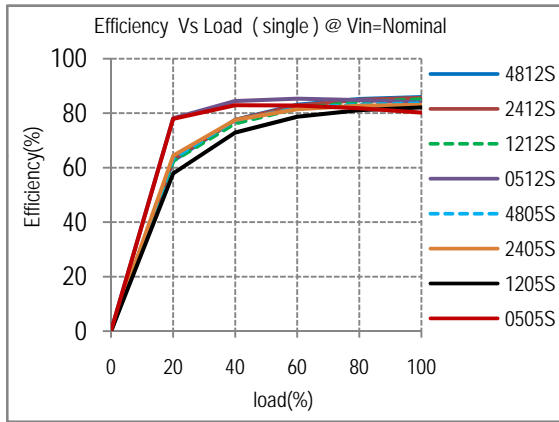

**Package Style and Pinning (mm)**

8 Pin SIP Package

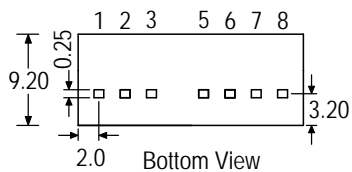
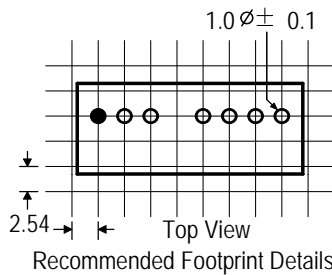
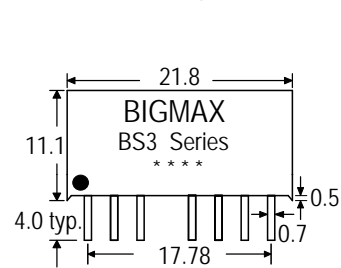

XX.X ± 0.25 mm  
XX.XX ± 0.15 mm

**Pin Connections**

Pin#	Single	Dual
1	-Vin	-Vin
2	+Vin	+Vin
3	CTRL	CTRL
5	NC	NC
6	+Vout	+Vout
7	-Vout	COM
8	NC	-Vout

NC=No Connection  
CTRL=Remote ON/OFF Control

**Tube Outline Dimensions (mm)**

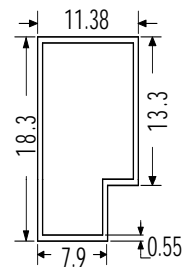

Tolerance:  
XX.X ± 0.5 mm

Note:  
L=520 ± 2 mm

Devices per tube quantity: 23PCS